



Exo skeleton arm with three degree of freedom

Geetha rani T O, Ajay Kumar Thakur, Bickey Shah, Bijet Swarup,
Sonu Kumar shah

Department of Electronics and communication
Siddaganga institute of Technology
Tumkur, India

Date of Submission: 22-02-2021

Date of Acceptance: 06-03-2021

Abstract: Bionics is the sphere that offers with passive and active prosthetic limb design. The passive conventional prosthesis contains consistent mechanical homes in order that the motion of joints is not much like that of human beings at the same time as the lively kind prosthesis more realistically represents human movement. The latter is, but, greater costly than passive prosthesis and consumes greater electricity. traditional low-price arm prosthesis, available, is essentially a fixed passive structure which makes the operating of arm viable with some issue. Semi-energetic kind prosthesis is less costly and its results are very similar to that of lively type prosthesis and it's far a better solution to govern the human arm movement artificially. This paper is based on the design of a bionic arm that can emulate a pattern similar to that of a normal persons arm movement. It focuses on developing a more economic design for monoplegic patients to re-train their muscles and revive the feeling of movement of their arm at a lower cost than what is available on the market today. Semi-active type of bionic arm is designed using geared DC motors which are interfaced to Arduino. The proposed exoskeleton arm has three degrees-of-freedom at the shoulder, elbow and wrist joints. Controlling the exoskeleton arm is performed by voice recognition Bluetooth module. This could assist the paralysis persons without any assistance.

Keywords- exoskeleton,

I. INTRODUCTION

A powered exoskeleton, additionally referred to as powered armor, exoframe, or exosuit, is a cell device consisting of an outer framework worn with the aid of someone, and powered by a system of vehicles, hydraulics, pneumatics or levers that gives you at least a part of the energy for arm movement. They are usually designed for military

use, to assist soldiers to carry heavy masses. In civilian areas, comparable exoskeletons could be used to help firefighters and other rescue employees to continue to exist from dangerous environments. In clinical field exoskeleton can be used to support monoplegic sufferers, or as an help to permit nurses to move heavy sufferers.

An electric exoskeleton arm reduces the metabolic electricity used while lifting and wearing a load. The exoskeleton augments human by providing mechanical strength to the elbow.

Human motion is an important function which is related to the movement in upper or lower limb. Patients who have injured or damaged of brain will lost the movement controlling function. Every year, 15 million people worldwide suffer from stroke. More than 85 % of them survive, but only 10 % recover completely [1]. The rest deal with mobility impairment and cognitive disabilities.

The proposed system assists physically challenged persons like paralysis patients having acute diseases. In particular, this is useful for the monoplegic persons to move their arm without any assistance. This also enables severely disabled person's arm movement to control independently using voice with three degree of freedom at shoulder, elbow and wrist joints that provide reliability, safety and comfort. Robotic Arm provides unique mobility for the disabled and elderly with motor impairments. The rest of this paper Section II is describes the system hardware. Flow chart is discussed in Section III. Results are discussed in Section IV. finally concludes the paper in Section V.

II. SYSTEM HARDWARE

The block diagram of Exoskeleton arm is shown in Figure.1 and Figure 2 shows its circuit diagram.

Voice Recognition App, speech to text installed in android mobile is used to send voice



command to control the arm. The app and Bluetooth module HC-05 are wirelessly paired.

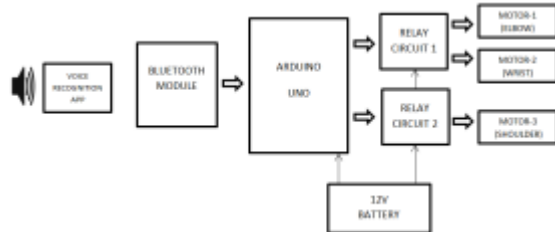

Figure 1: block diagram of Exoskeleton arm

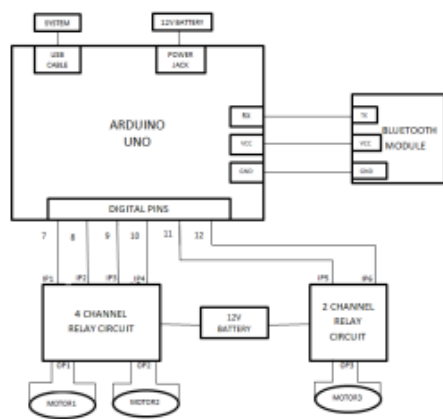

Figure 2: Circuit diagram of Exoskeleton arm

HC-05 module transfers the data to Arduino through serial communication. The Arduino processes the data and checks for matching state. If the data is matched with the state, it sends output signal from digital pins to the respective relay. Relay circuit 1 in Figure 1 has four channel relay, connected to motor 1 for elbow movement and motor 2 for wrist movement and relay circuit 2 has two channel relay connected to motor 3 for shoulder movement.

To move the arm in three degree of freedom, the system has seven states where each state defines specific movement of the motor. Two 10 rpm 5 kg torque DC gear motors are used for the movement of the wrist and elbow, and a 60 rpm 13 kg torque DC motor is used for movement of the shoulder.

The Bluetooth module HC-05 sends the input data to Arduino. In Arduino, the received data is processed and sends to the relay circuits and the relay circuits drive the respective motors as per the data to move the exoskeleton arm.

The voice recognition app, speech-to-text is available in play store and it can be installed to any android device. A blue button appears in voice recognition app when the android device is paired with Bluetooth module by pressing this button

numeric command as shown in Table-1 can be given to control the arm movement of the monoplegic patient.

This command is received by Bluetooth module. States are numeric commands which are read through voice recognition app. The patient has to say one of the state as shown in Table-1 to move specific joint in clockwise or anticlockwise direction.

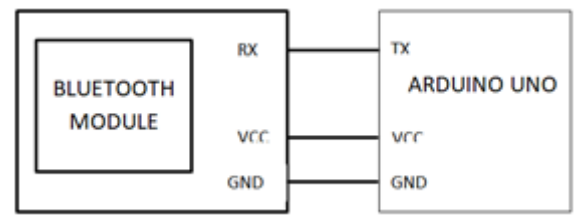

Figure 3: Connection of Bluetooth module to Arduino UNO

Table-1: Direction of rotation of motors

| State | Motor-1 (Elbow) | Motor-2 (Wrist) | Motor-3 (Shoulder) |
|-------|----------------------|----------------------|----------------------|
| 1 | Clockwise (Up) | Off | Off |
| 2 | Anticlockwise (Down) | Off | Off |
| 3 | Off | Clockwise (Up) | Off |
| 4 | Off | Anticlockwise (Down) | Off |
| 5 | Off | Off | Clockwise (Up) |
| 6 | Off | Off | Anticlockwise (Down) |
| 7 | Off | Off | Off |

Bluetooth module is a wireless communication protocol which can be operated in transmitting or receiving mode. HC-05 is used to receive the commands from the mobile app which is transferred to Arduino UNO. The connection of bluetooth module with Arduino is shown in Figure 3.

A. Arduino UNO

The Arduino Uno is a microcontroller board based on the ATmega328. The connection of Arduino UNO with relay circuit and Bluetooth module is shown in Figure 4. The main function of Arduino is to receive voice command from voice recognition app via HC-05 Bluetooth module. If the received input signal is matched with one of the state, then the respective digital pin will be activated.



These digital pins will send the signal to the corresponding relay circuit for the movement of particular joint motor in the respective direction.

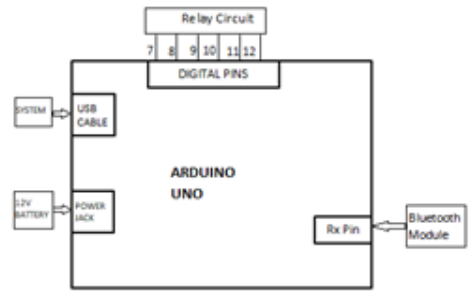

Figure 4: Connection of Arduino UNO

B. Relay Circuit

A relay is a prime component of relay circuit. The relay circuit is used to provide electrical isolation between the Arduino and motors. The current from I/O pins of Arduino is 20 mA which is not sufficient to drive the motors. The relay circuit amplifies the current from 20mA to 40 mA to drive the motors. Here six relays are used in which 4 relays are modeled on four channel circuit which is connected with Motor 1 and 2 and two relays are connected with Motor-3 as shown in Figure 5.

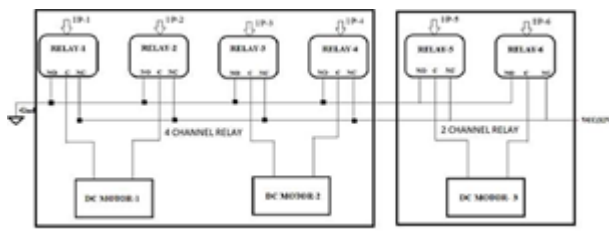

Figure 5: Connection of Relay circuit

If IP-1 and IP-2 digital pins are “10”, DC motor-1 rotates in clockwise direction and for “01” it rotates in anticlockwise direction, similarly for motor 2 and 3.

C. Design of DC motors

The torque of a DC motor is defined as its ability to rotate the load about an axis. The calculations and the choice for the motors are given in this section. The average height of patient is taken as 5 ft. 5.5 in (166.37 cm) and the average weight corresponding to this height is 65.3 kg.

The human hand weighs on an average of 5.335% of the total body weight [7]. The average weight of the human hand is calculated using equation 1.

$$5.335/100 \times 65.3 \text{kg} = 3.48 \text{kg} \quad (1)$$

The average weight of a human hand is found out to be 3.48 kg from equation (1). The total weight of the frame is 2.7 kg and if the approximate load to be lifted is 1 to 2 kg,

hence the torque of the motor is chosen as 13 kg with 60 RPM for smooth movement of arm.

The human forearm and wrist weighs on an average of 1.72% and 0.57% of the total body weight. The average weight of the human forearm and wrist are calculated using equation 2 and 3.

$$1.72/100 \times 65.3 \text{kg} = 1.12 \text{kg} \quad (2)$$

$$0.57/100 \times 65.3 \text{kg} = 0.37 \text{kg} \quad (3)$$

The average weight of the human forearm and wrist are found out to be 1.12 kg and 0.37kg from equation (2) and (3) respectively. Therefore the choice of DC motors for the forearm and wrist are taken as 5kg motor with an RPM of 10.

Two 10 RPM, 5 kg-cm torque DC motors are used for the movement of the elbow and wrist joint, and a 60 RPM, 13 kg-cm torque DC motor is used for movement of the shoulder joint.

D. Mechanical Structure of Exoskeleton

The structure of exoskeleton is designed using galvanized aluminum and assembled using the nut and bolt and some part welded and Velcro straps and belt are used to attach the exoskeleton arm to the patients arm. The physical structure of exoskeleton arm showing the measurement and placement of motors is as shown in Figure 6.

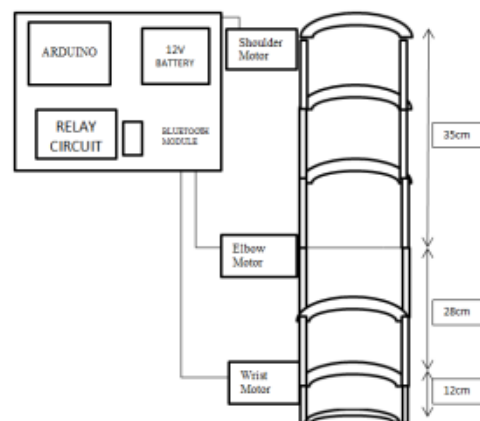

Figure 6: Physical structure of Exoskeleton arm

The length of human upper arm is 17.25%, the length of human forearm is 15.85% and the length of human wrist is 5.75% of the total human height [7]. Considering the average human height of 166.37 cm, the length of human upper arm, forearm and wrist are calculated using equation (4) to (6) respectively:

$$17.25/100 \times 166.37 \text{cm} = 28.69 \text{cm} \quad (4)$$

$$15.85/100 \times 166.37 \text{cm} = 26.36 \text{cm} \quad (5)$$



$5.75/100 \times 166.37 \text{ cm} = 9.56 \text{ cm}$ (6)
With tolerance the total length of Exoskeleton arm is designed for 75 cm.

III .FLOW CHART

Figure: 7 Depicts the flowchart of the Exoskeleton arm.

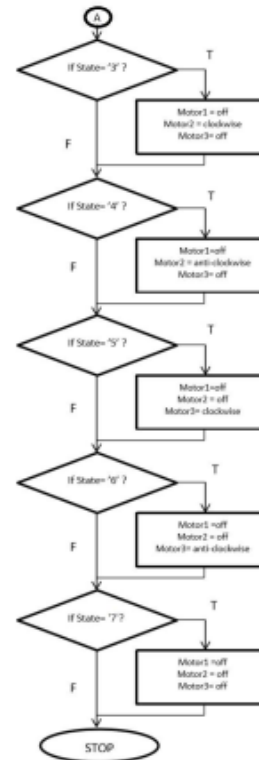
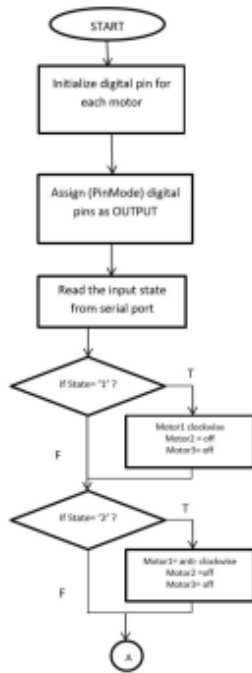

Figure 7: Flow chart of the Exoskeleton arm

IV. RESULTS

This section gives the experimental results. The front view and side view of the exoskeleton arm is as shown in Figure 8. It is designed using galvanized aluminum, Velcro straps and belt are used to attach the exoskeleton arm to the patients arm. The arm consists of three motors. 5 kg torque 10 RPM motors at forearm and wrist section and 13 kg torque 60 RPM motor at shoulder section. As shown in Figure 8 the exoskeleton arm is attached to the patients arm using Velcro straps and belt.



Figure 8: Front view and side view of Exoskeleton arm



When voice command 111 is given in voice recognition app, the elbow motor moves 90° anti-clockwise lifting the hand up side which is as shown in Figure 9.



Figure 9: Movement of elbow anti-clockwise using voice command 111

When voice command 55 is given in voice recognition app, the shoulder motor moves 90 degree lifting the hand up side which is as shown in Figure 10.



Figure 10: Lifting the arm using voice command 55

The embedded circuit of the system consist of Arduino UNO, 4 channel relay, 2 channel relay, Bluetooth module and 12V battery as shown in Figure 11.

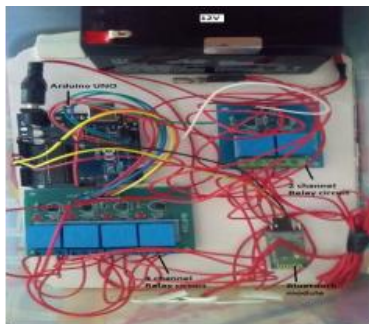

Figure 11: Snapshot of Exoskeleton arm

To check the accuracy, the test for all the state of the commands is given. Two people uttered each command five times with different accent and the success rate is in Table -2

Table-2

| State | Person-1 | Person-2 |
|-------|----------|----------|
| 1 | 4/5 | 5/5 |
| 2 | 2/5 | 3/5 |
| 3 | 5/5 | 4/5 |
| 4 | 4/5 | 4/5 |
| 5 | 4/5 | 4/5 |
| 6 | 3/5 | 3/5 |

V. CONCLUSION

The system assist monoplegic patients to move their arm with three degrees of freedom. Voice recognition app and Bluetooth module are used to provide inputs to the Arduino. Voice recognition app takes the numeric command from the user and wirelessly send it to the Bluetooth module which is connected to receiver section of Arduino. The direction of rotation of the motors are controlled by Arduino. Geared motors are used so that they have higher driving capabilities compared to other motors.

The Exoskeleton arm can also help people to lift the heavy loads by increasing their endurance power. Apart from the movement of the human arm, the aluminum frame also protects the arm from external injury. These features can be helpful in the war field to carry the injured soldiers and rescue operations.

REFERENCES

- [1]. L.E. Kahn, P.S. Lum, W.Z. Rymer, D.J. Reikensmeier, "Robot assisted movement training for the stroke-impaired arm: Does it matter what the robot does? ", Journal of Rehabilitation Research and Development, V42, Nr. 5, pp. 619-630, August/September 2006.
- [2]. H. Kawamoto, Y. Sankai, "Comfortable Power Assist Control Method for Walking Aid by HAL-3", IEEE Int. Conf. on Systems, Man and Cybernetics, 6-9 October 2002.
- [3]. D. P. Ferris, G. S. Sawicki, A. R. Domingo, "Powered Lower Limb Orthoses for Gait Rehabilitation", Top Spinal Cord Injury Rehabilitation Journal, Vol. 11(2), pp. 34-49, 2005.